

## Fittings

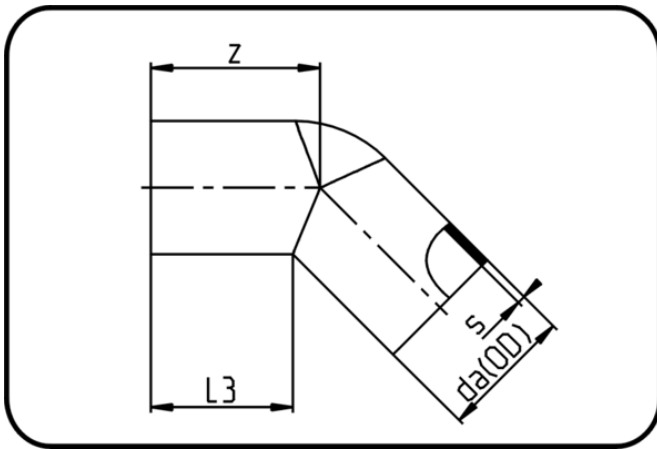

Code: 060

- **Elbow 45°**
- long spigot
- injection moulded
- **Butt+IR-welding**
- **PP Pure grey**

Dimension	Code	Detail	da(OD) mm	s mm	z mm	L3 mm	Weight
20	72.060.0020.11	20X1,9 SDR11 ISO S-5	20	1,9	44	39	0.013
25	72.060.0025.11	25X2,3 SDR11 ISO S-5	25	2,3	48	42	0.019
32	72.060.0032.11	32X2,9 SDR11 ISO S-5	32	2,9	57	49	0.033
40	72.060.0040.11	40X3,7 SDR11 ISO S-5	40	3,7	63	53	0.052
50	72.060.0050.11	50X4,6 SDR11 ISO S-5	50	4,6	70	57	0.09
63	72.060.0063.11	63X5,8 SDR11 ISO S-5	63	5,8	80	67	0.166
75	72.060.0075.11	75X6,8 SDR11 ISO S-5	75	6,8	90	72,5	0.254
90	72.060.0090.11	90X8,2 SDR11 ISO S-5	90	8,2	104	82	0.416
110	72.060.0110.11	110X10,0 SDR11 ISO S-5	110	10	114	85	0.658
125	72.060.0125.11	125X11,4 SDR11 ISO S-5	125	11,4	132,5	99,5	1.023
140	72.060.0140.11	140X12,7 SDR11 ISO S-5	140	12,7	136	100	1.38
160	72.060.0160.11	160X14,6 SDR11 ISO S-5	160	14,6	156,5	116,5	2.059
180	72.060.0180.11	180X16,4 SDR11 ISO S-5	180	16,4	176,5	131,5	2.8
200	72.060.0200.11	200X18,2 SDR11 ISO S-5	200	18,2	170,5	120,5	3.5
225	72.060.0225.11	225X20,5 SDR11 ISO S-5	225	20,5	182,5	128	4.6
250	72.060.0250.11	250X22,7 SDR11 ISO S-5	250	22,7	217	160	6.8
280	72.060.0280.11	280X25,4 SDR11 ISO S-5	280	25,4	238	173	9.121
315	72.060.0315.11	315X28,6 SDR11 ISO S-5	315	28,6	256	179	12.3